

- * Designed for use with Leading Controller Chips
- * Provides DC/DC Conversion & Isolation

- * Design Engineering Support Available
- * Multiple Configurations

GENERAL APPLICATION INFORMATION

Premier Magnetics' Switch Mode Output transformers have been designed for use with the most popular current-mode switching regulators such as Linear Technologies/Analog Devices LT1X7X & Maxim MAX25XX series of High Efficiency Switching Regulators. These output transformers have been optimized to provide maximum power throughput in the smallest packages currently available. This combination of components finds wide use in Distributed Power Systems where a main dc voltage bus is converted for use on or near the circuits being served.

These types of switching regulators provide a very simple solution to power conversion designs. The inductor or transformer used are critical to the overall performance of the converter and typically define the overall efficiency, output power and physical size.

The following tables of transformers were designed for use in the Flyback Buck-Boost circuit configuration. This conversion topology allows the output voltage to be regulated higher or lower than the input voltage. It can also provide isolated or non-isolated multiple outputs. Typical efficiency of this topology is 75%.

Below is a typical application circuit utilizing Linear Technologies LT1X7X switching regulator in the flyback buck-boost configuration. The use of Premier's VTP-01XXX or VTK-01XXX optional output filter choke will drastically reduce output ripple and noise. The component values listed are intended for reference purposes only. The Output Filter(s), Damper Network & Foldback Current Limiting Network are optional depending on the specific application.

General Component Values:

- | | |
|---|---------------------------------|
| R3 = 1.0K 1/8W | D1 = MBRXXX, Schottky Rectifier |
| C3 = 2.2uF Film | D2 = MBRXXX, Schottky Rectifier |
| R4 = 1.5K 1W Snubber | D3 = MBRXXX, Schottky Rectifier |
| C4 = .47uF Film | C1 = Electrolytic |
| R5 = 2.0K 1W | C7 = Electrolytic |
| C5 = 0.1uF Ceramic | R6 = 1% Metal Film as needed. |
| L1 = 10uHy @ Rated DC amps (VTP-XXXX) | C6 = 1000uF Electrolytic |
| L2 = 10uHy @ Rated DC amps (VTP-XXXX) | C8 = 1000uF Electrolytic |
| R1 = 1% Metal Film, For 5Vdc = 3.0K, For 9Vdc = 9.09K | |
| R1 = $[(V_{out} - V_{ref}) / V_{ref}] * R2$, where $V_{ref} = 1.244$ for LT1X7X series | |
| R2 = 1% Metal Film, For 5Vdc = 1.0K, For 9Vdc = 1.5K | |
| C2 = Input Bypass Capacitor 100uF Electrolytic | |

SCHEMATIC

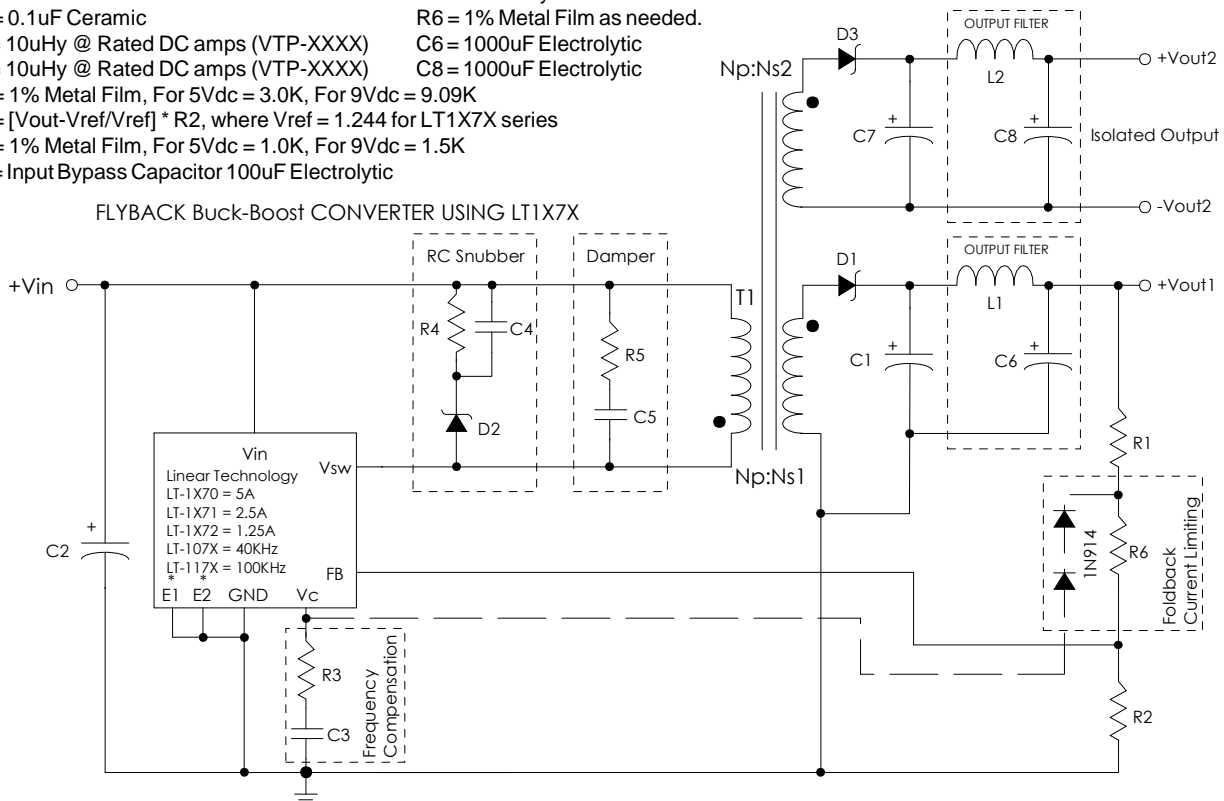

Specifications subject to change without notice.

pmsm 03/19



DC/DC POWER CONVERSION TRANSFORMERS

GENERAL ELECTRICAL SPECIFICATIONS AT 25°C - OPERATING TEMPERATURE RANGE 0°C TO +70°C

To receive complete specifications & application information, request the respective part number data sheet.

PART NUMBER	Designed For Use With	APPLICATION			PRIMARY OCL -HY Typ.	HI-POT Vdc Min.	Temp Rise °C Typ.	General Notes	PCB Mount Method
		Vin (Vdc)	Vout (Vdc)	Io_max (mA)					
PM-SM02	LT1071	12.0	5.0	1000	140	550	20	Feed Back Output	THRU
PM-SM03	LT1071	12.0	9.0	1000	110	550	35	Feed Back Output	THRU
PM-SM04	LT1071	24.0	5.0	2000	200	550	40	Feed Back Output	THRU
PM-SM05	LT1071	24.0	5.0	2000	200	550	40	Feed Back Output	THRU
PM-SM07	LT1070	12.0	5.0	2000	50	550	40	Feed Back Output	THRU
PM-SM09	LT1070	12.0	5.0	4000	135	250	50	Feed Back Output	THRU
TSD-546 Output #2	LT1072	12.0 -----	5.0 9.0	220 160	250 -----	550 550	15 -----	Feed Back Output Isolated Output	THRU
TSD-578 Output #2 Output #3 = Tap off #2	LT1072	24.0 ----- -----	5.0 5.0 6.0	100 200 32	1000 ----- -----	500 500 -----	15 ----- -----	Isolated Output #1 Isolated Output #2 Tap Output off #2	THRU
TSD-648 Outputs #2 & #3: ±15.0	LT1171	5.0 -----	5.0 ±15.0	60 ±100	48 -----	750 750	15 -----	Isolated Output, Opto F.B. Isolated + Linear Reg.	SMD
TSD-649	LT1076HV	18-50	15.0	700	80	N/A	15	Positive Buck	SMD
TSD-652 Output #2 = Auxiliary	MAX783	5.5-30 -----	3.3 15.0	3100 220	10 -----	500 500	10 -----	Positive Buck Auxiliary Output	SMD
TSD-723	LT1070	12.0	15.0	2000	210	550	30	Isolated Output	THRU
TSD-725 13V TAP Output 15V TAP Output	LT1172	12.0 ----- -----	5.0 13.0 15.0	500 150 60	100 ----- -----	550 ----- -----	15 ----- -----	Feed Back Output Tap Output Tap Output	SMD
TSD-726 Output #2, 13V TAP Output #3, 15V TAP	LT1172	12.0 ----- -----	5.0 13.0 15.0	100 40 200	100 ----- -----	100 ----- -----	15 ----- -----	Feed Back Output Tap Output Tap Output	SMD
TSD-727	LT1172	9-33	5.0	200	1000	1000	10	Isolated Output	THRU
TSD-730 Output #2 & #3: +15V (TSD-933 = THRU VERSION)	LT1172	18-30 -----	5.0 ±15.0	250 ±25	1000 -----	500 500	10 -----	Isolated Output Isolated Output	SMD
DISCRETE SELF OSCILLATING PUSH-PULL CONVERTERS, DUAL SECONDARIES									
TSD-643 40KHz Full Wave C.T. Full Brige Dual Full Brige		12.0 ----- -----	24 48 ± 24	420 210 ± 210	2300	3750 3750 3750	25	Isolated Output Isolated Output Isolated Output	THRU
TSD-644 40KHz Full Wave C.T. Full Brige Dual Full Brige		12.0 ----- -----	100 200 ±100	50 25 ± 25	2300	3750 3750 3750	25	Isolated Output Isolated Output Isolated Output	THRU
TSD-645 40KHz Full Wave C.T. Full Brige Dual Full Brige		52.0 ----- -----	100 200 ±100	100 50 ± 50	6800	3750 3750 3750	25	Isolated Output Isolated Output Isolated Output	THRU
TSD-742 1.0KHz DC to AC		1.5-3.5	85rms	8 rms	31mH	500	10	Isolated rms Output	SMD

Specifications subject to change without notice.

pmsm 03/19

20381 BARENTS SEA CIRCLE, LAKE FOREST, CA 92630 Ñ TEL: (949) 452-0511 Ñ FAX: (949) 452-0512 Ñ <http://www.premiermag.com>

DC/DC POWER CONVERSION TRANSFORMERS

GENERAL ELECTRICAL SPECIFICATIONS AT 25°C - OPERATING TEMPERATURE RANGE 0°C TO +70°C

To receive complete specifications & application information, request the respective part number data sheet.

PART NUMBER	Designed For Use With	APPLICATION			PRIMARY OCL -HY Typ.	HI-POT Vdc Min.	Temp Rise °C Typ.	General Notes	PCB Mount Method
		Vin (Vdc)	Vout (Vdc)	Io_max (mA)					
TSD-750 Output #2	LT1172	10-30 ----- -----	24.0 24.0	50 50	610 ----- -----	500 500 500	10 ----- -----	Isolated Output Isolated Output	SMD
TSD-769 Output #2 Output #3 = Auxiliary	LT1071	9-32 ----- -----	32.0 20.0 8.0	100 100 20	410 ----- -----	500 500 500	25 ----- -----	Isolated Output Isolated Output Isolated Output	THRU
TSD-826 Output #2 Outputs #3 & #4: ±48V	LT1171	7-16 ----- -----	5.0 -5.0 ± 48.0	500 20 ±50	55 ----- -----	500 500 500	25 ----- -----	Feed back Output Second Output Isolated Outputs ±48V	SMD
TSD-834 Output #2	UC2843	130-260 ----- -----	+5.0 -5.0	+1000 -10	324 ----- -----	1500 ----- -----	15 ----- -----	Isolated Output, Opto F.B. Isolated Output	THRU
TSD-839 Output #2 & #3: ±20Vdc Output #4 & #5: ±30Vdc	LT1171	12.0 ----- -----	+9.0 ±20.0 ±30.0	+250 ±80 ±10	150 ----- -----	300 ----- -----	15 ----- -----	Isolated Output, Opto F.B. Isolated Output Isolated Output	SMD
TSD-841 Output #2	LT1070	5-30V ----- -----	-180.0 +60.0	-50 +50	45 ----- -----	500 ----- -----	20 ----- -----	Isolated Output, Opto F.B. Isolated Output	THRU
TSD-849 3.3V TAP Output Output #2	UC2843	100-280 ----- -----	+5.0 +3.3 -5.5	+450 +200 -100	292 ----- -----	1500 ----- -----	15 ----- -----	Isolated Output, Opto F.B. Tap Output Isolated Output	SMD
TSD-850 Output #2 -24V TAP Output off #2	UC2843	100-280 ----- -----	-48.0 -65.0 -24.0	-40 -75 -150	200 ----- -----	1500 ----- -----	15 ----- -----	Isolated Output, Opto F.B. Isolated Output Tap Output	SMD
TSD-851 -28V TAP Output	UC2843	120-260 ----- -----	-48.0 -28.0	-20 -200	324 ----- -----	1500 ----- -----	15 ----- -----	Isolated Output, Opto F.B. Tap Output	THRU
TSD-852 Output #2	UC2843	130-260 ----- -----	+12.0 -160.0	+100 -200	324 ----- -----	1500 ----- -----	15 ----- -----	Isolated Output, Opto F.B. Isolated Output	THRU
TSD-878 Output #2	LT1170	24.0 ----- -----	5.0 12.0	1250 1250	68 ----- -----	1500 ----- -----	30 ----- -----	Isolated Output, Opto F.B. Isolated Output	THRU
TSD-879	LT1170	24.0	±12.0	±250	150	1500	15	Isolated Output, Opto F.B.	SMD
TSD-887	LT1170	15-21	175.0	120	63.0	1000	20	Direct Feedback	THRU
TSD-906 Output #2	LM2588T WITHREG'S	24.0 ----- -----	5.0 15.0	2500 1000	160 ----- -----	1000 ----- -----	15 ----- -----	Isolated Output, Opto F.B. Iso. Linear Reg Output	THRU
TSD-913	LT1171	10-30	5.0	1200	100.0	1500	10	Isolated Output, Opto F.B.	THRU
TSD-933 Output #2 & #3	LT1172	18-30 ----- -----	5.0 ±15.0	250 ±25	1000 ----- -----	500 500	10 ----- -----	Isolated Output Isolated Output	THRU
TSD-980 Output #2	LT1082	12-40 ----- -----	12.0 12.0	125 125	1300 ----- -----	1500 1500	10 ----- -----	Isolated Output Isolated Output	THRU
TSD-989 Output #2 & #3	LT1172	8-40 ----- -----	5.0 ±10.0	200 ±50	100 ----- -----	500	10 ----- -----	Direct Feedback Output Isolated Output	SMD
TSD-1040 Output #1 Output #2	LT1172	8-40 ----- -----	5.0 12.0 20.0	200 80 80	110 ----- -----	250 250	10 ----- -----	Direct Feedback Output Isolated Output #1 Isolated Output #2	SMD

Specifications subject to change without notice.

pmsm 03/19



DC/DC POWER CONVERSION TRANSFORMERS

GENERAL ELECTRICAL SPECIFICATIONS AT 25°C - OPERATING TEMPERATURE RANGE 0°C TO +70°C

To receive complete specifications & application information, request the respective part number data sheet.

PART NUMBER	Designed For Use With	APPLICATION			PRIMARY OCL -HY Typ.	HI-POT Vdc Min.	Temp Rise °C Typ.	General Notes	PCB Mount Method
		Vin (Vdc)	Vout (Vdc)	Io_max (mA)					
TSD-1145	LM2585-5.0	6-18	5.0	600	64.0	250	15	Direct Feedback	SMD

Specifications subject to change without notice.

DC/DC POWER CONVERSION TRANSFORMERS

- * Designed to Support Maxim's MAX253
- * 1500Vrms Minimum Isolation Voltage
- * Designed For $\geq 125\text{KHz}$, 50% Duty Cycle Push-Pull Operation @ 1.0 Watt Output

- * Low profile 8-Pin SMD Package
- * Industry Standard Package
- * Multiple Configurations

ELECTRICAL SPECIFICATIONS AT 25°C - OPERATING TEMPERATURE RANGE -40°C TO +85°C

PART NUMBER	TURNS RATIO (Pri:Sec $\pm 5\%$)	PRIMARY OCL (-H Min.)	Primary Pins	TYPICAL APPLICATION	PR/SEC HI-POT (Vrms)	GENERAL CHARACTERISTICS
PM-SM15	1CT : 1.00	150	1-4	+5V to +10V	1500	Volt Doubler Driving a Regulator
PM-SM16	1CT : 1.38CT	150	1-4	+5V to +5V	1500	Full Wave Center Tap
PM-SM17	1CT : 2.00CT	150	1-4	+3.3V to +5V	1500	Full Wave Center Tap
PM-SM18	1CT : 0.667	150	1-4	+5V to +5V	1500	Full Wave Bridge
PM-SM19	1CT : 1.6 CT	150	1-4		1500	Full Wave Center Tap

MECHANICALS

RECOMMENDED P.C.B. LAYOUT

Dimensions in mm (inches)

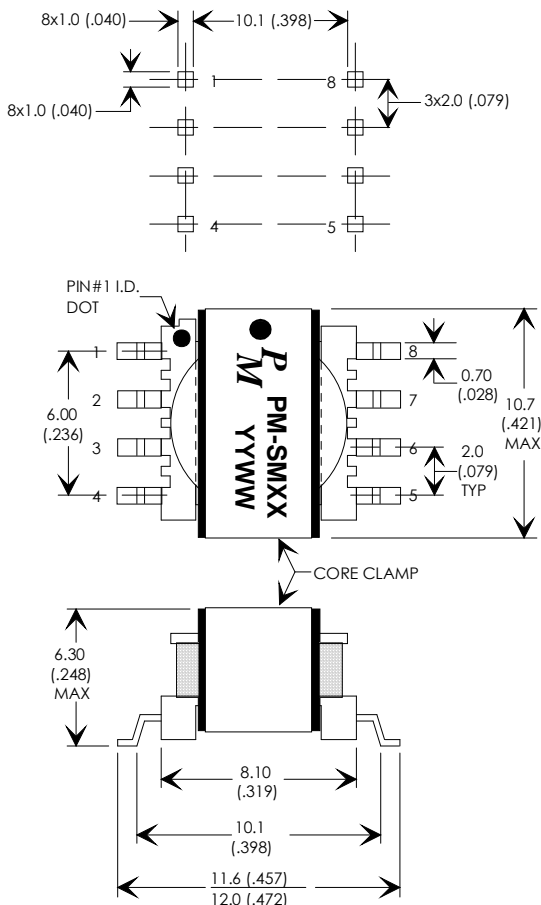

TYPICAL APPLICATIONS

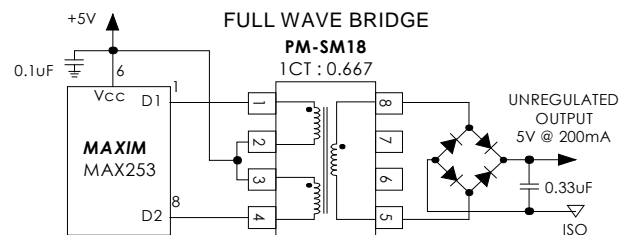
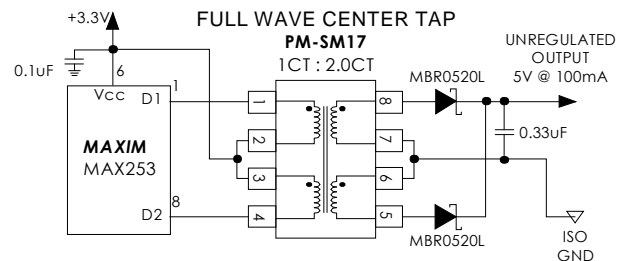
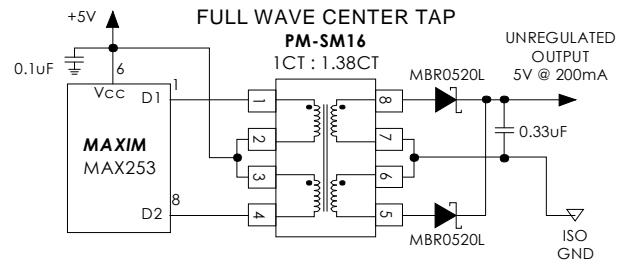
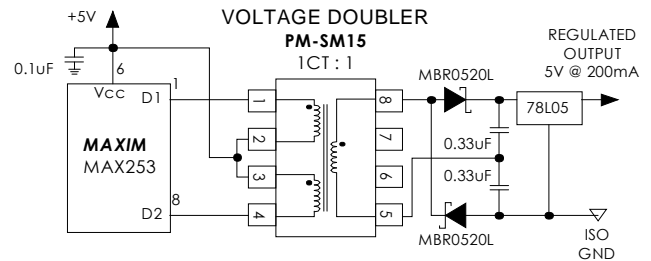

Specifications subject to change without notice.

03/19

- * Designed to Support ADM2482E, ADM2485 and ADM2487E RS-485
- * Ambient & Storage Temp -40C to +125C

- * Low profile 8-Pin SMD Package
- * Industry Standard Package
- * RoHS

ELECTRICAL SPECIFICATIONS AT 25°C

PART NUMBER	Pri / Sec Voltage	Turns Ratio	PRIMARY Pin 4-3 (-H Min.)	Leakage Inductance (-H Max.)	DCR Per WDG		Volt-Time (V--HSec)	PRI/SEC HI-POT (Vrms)	Schematics
					Pri	Sec			
PM-SM50	5V to 6V	1CT:1.5CT	45.6	1.00	0.130	0.260	34.4	2500	A
PM-SM51	3.3V to 6V	1CT:2.2CT	17.8	0.43	0.086	0.230	21.5	2500	A
PM-SM54	3.3V to 6V	1CT:2.2CT	17.8	0.43	0.086	0.232	22.0	2500	A

MECHANICALS

Schematics

RECOMMENDED P.C.B. LAYOUT

Dimensions in mm (inches)

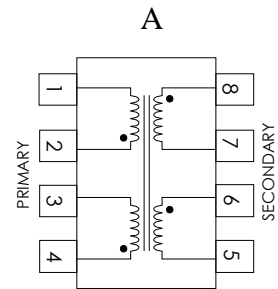
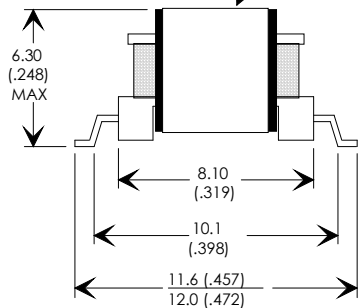
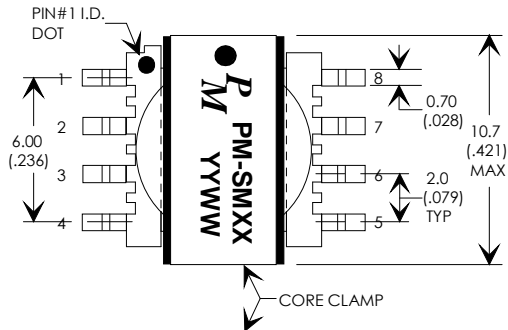
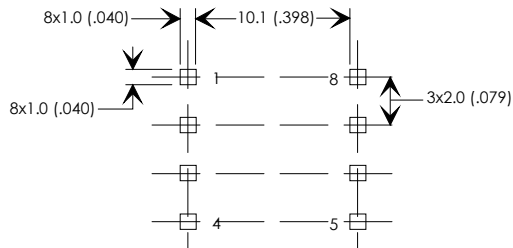

Specifications subject to change without notice.

pmsm 03/19