

**"INNOVATORS IN MAGNETICS TECHNOLOGY"**

- ① Ideal for LAN & Telecom Applications
- ② Filters Common Mode Noise
- ③ Provides EMI Supression
- ④ Frequency Ranges 100KHz to 500 MHz
- ⑤ 500Vrms Isolation Minimum
- ⑥ Thru-Hole & SMD Packages

**ELECTRICAL SPECIFICATIONS AT 25°C - OPERATING TEMPERATURE RANGE 0°C TO 70°C**

**THRU-HOLE CHOKES**

PART NUMBER	TURNS RATIO (±5%)	# of CORES x # of LINES	PRIMARY INDUCTANCE (OCL μH min)	LEAKAGE INDUCTANCE (μH max.)	PRI-SEC Cw/w (pf max.)	PRIMARY DCR (OHMS max.)	PACKAGE & SCHEMATIC
PM-SF01	1:1:1:1	1x4	4.0	.20	6.0	.17	1-A
PM-SF02	1:1:1:1	1x4	8.0	.20	10.0	.25	1-A
PM-SF03	1:1:1:1	1x4	24.0	.20	15.0	.30	1-A
PM-SF04	1:1:1:1:1	1x6	4.0	.20	6.0	.18	2-A
PM-SF05	1:1:1:1:1	1x6	24.0	.20	15.0	.35	2-A
PM-SF06	1:1:1:1	2x4	4.0	.20	6.0	.17	3-C
PM-SF07	1:1:1:1	2x4	8.0	.20	10.0	.25	3-C
PM-SF08	1:1:1:1	2x4	24.0	.20	15.0	.30	3-C
PM-SF09	1:1:1:1	1x4	36.0	.30	25.0	.35	1-A
PM-FS10	1:1	1x2	6.3	4.0	180	.65	7-A

**SURFACE MOUNT CHOKES**

PART NUMBER	TURNS RATIO(S) (±5%)	# of CORES x # of LINES	PRIMARY INDUCTANCE (OCL μH min)	LEAKAGE INDUCTANCE (μH max.)	PRI-SEC Cw/w (pf max.)	PRIMARY DCR (OHMS max.)	SCHEMATIC & PACKAGE
PM-SF30	1:1 x 2	2x2	37.0	.20	15.0	.30	5-A
PM-SF31	1:1 x 3	3x2	21.0	.20	15.0	.35	5-B
PM-SF32	1:1 x 4	4x2	36.0	.20	15.0	.35	5-C
PM-SF33	1:1:1:1	1x4	36.0	.30	25.0	.25	5-D
PM-SF34	1:1:1:1	1x4	24.0	.20	15.0	.30	4-A
PM-SF35	1:1 x 2	2x2	100	.30	35.0	.60	4-B

**SELF LEAD SURFACE MOUNT CHOKES**

PART NUMBER	TURNS RATIO(S) (±5%)	# of CORES x # of LINES	PRIMARY INDUCTANCE (OCL μH min)	LEAKAGE INDUCTANCE (μH max.)	PRI-SEC Cw/w (pf max.)	PRIMARY DCR (OHMS max.)	SCHEMATIC & PACKAGE
PM-SF50	1:1	1	877	N/A	N/A	.200	6-A
PM-SF51	1:1	1	663	N/A	N/A	.110	6-A

Specifications subject to change without notice.

pmsf 09/00

**PACKAGE "1"**

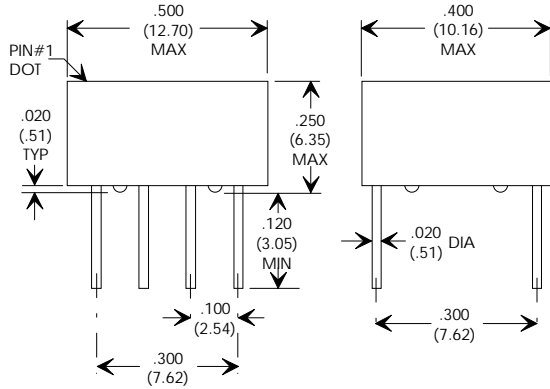

**SCHEMATIC**

**SCHEMATIC "A"**

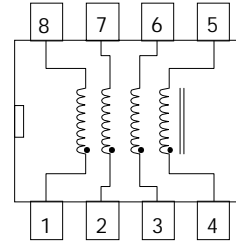

**PACKAGE "2"**

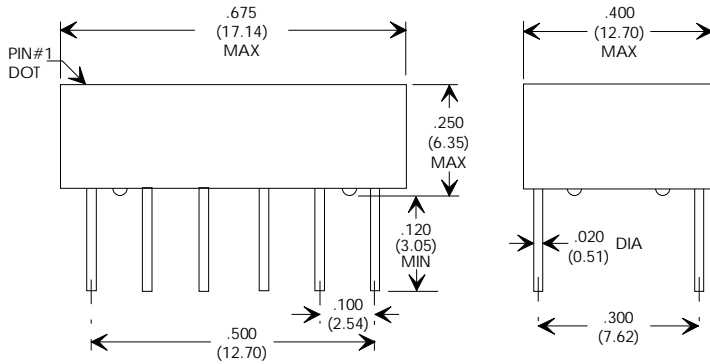

**SCHEMATIC "A"**

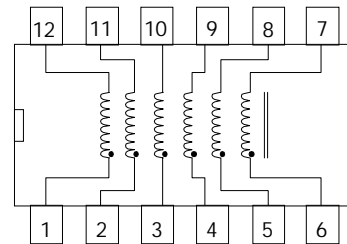

**PACKAGE "3"**

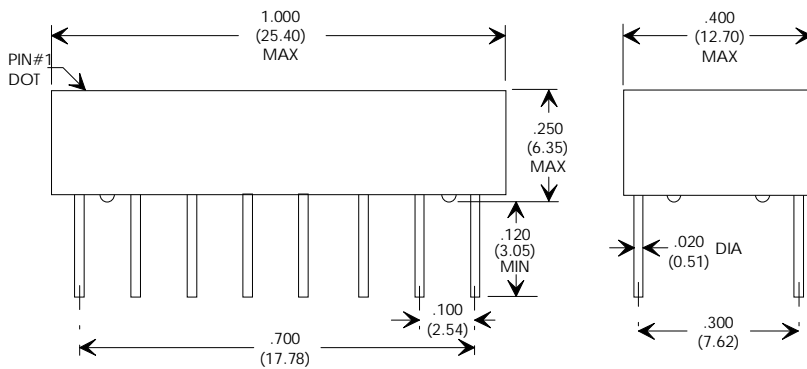

**SCHEMATIC "A"**

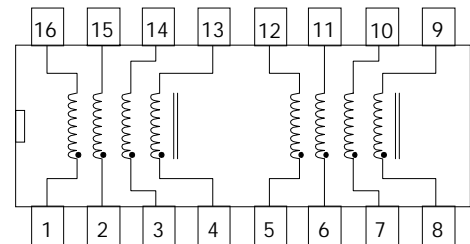

**PACKAGE "4"**

RECOMMENDED PCB LAYOUT

**SCHEMATIC "A"**

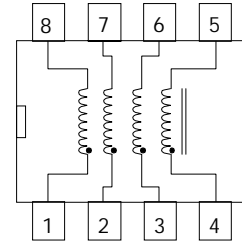
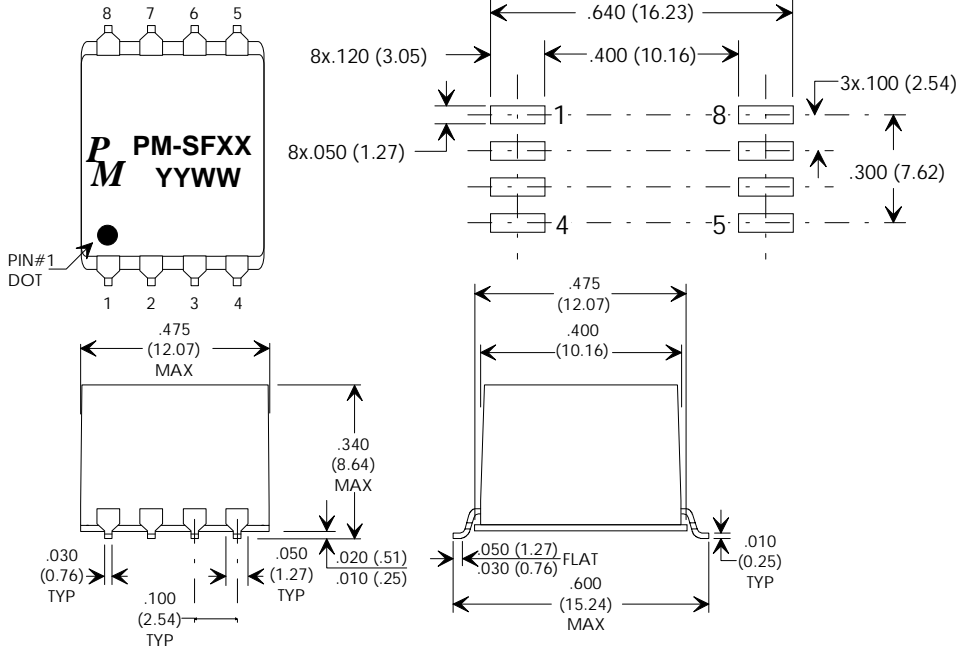

**SCHEMATIC "B"**

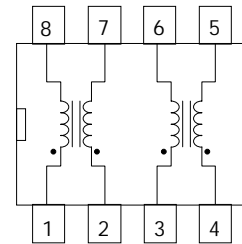

**PACKAGE "6"**

**SCHEMATIC "A"**

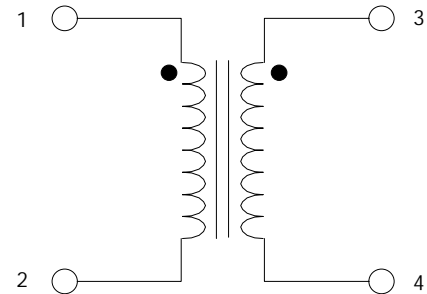
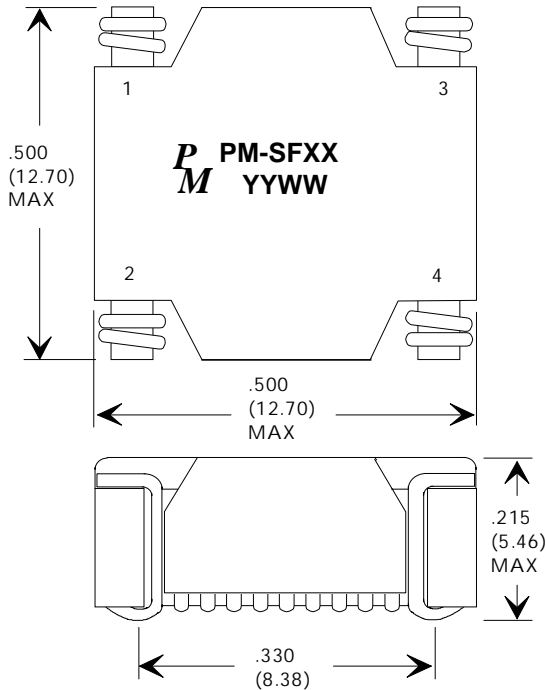



SIGNAL LINE FILTERS COMMON MODE CHOKES

PACKAGE "5"

SCHEMATIC

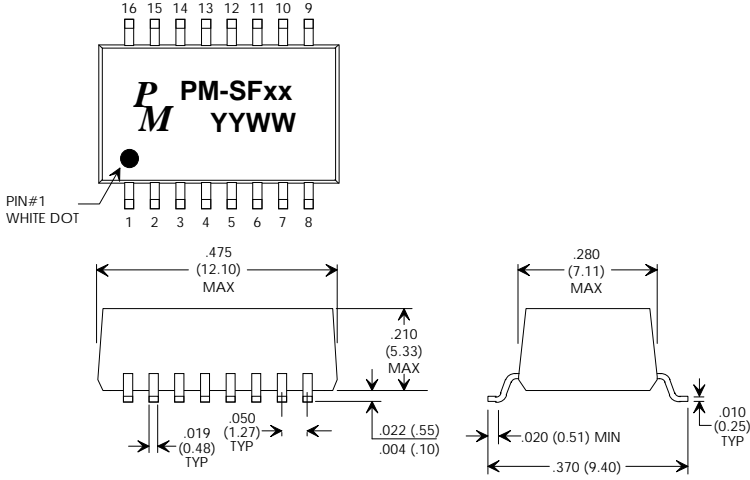

RECOMMENDED PCB LAYOUT

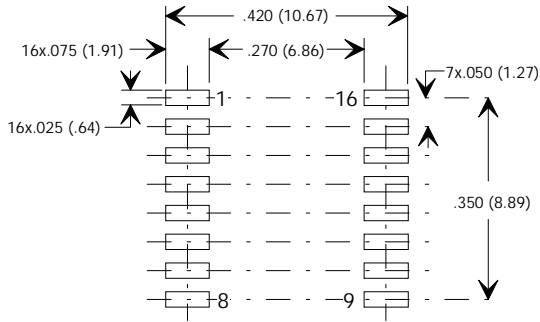

SCHEMATIC "A"

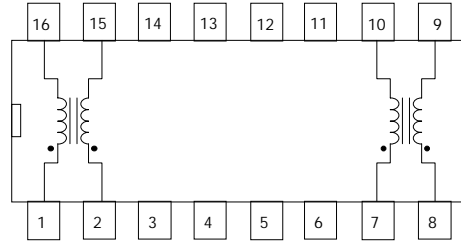

SCHEMATIC "B"

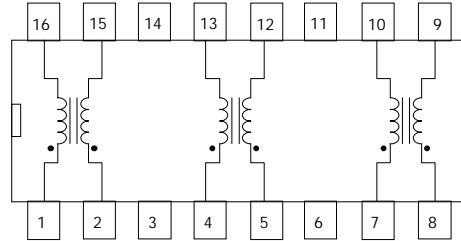

SCHEMATIC "C"

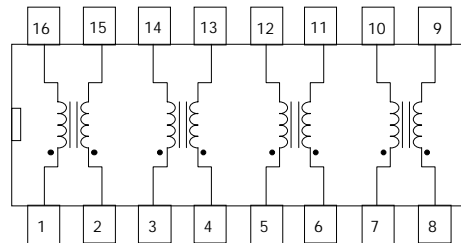

SCHEMATIC "D"

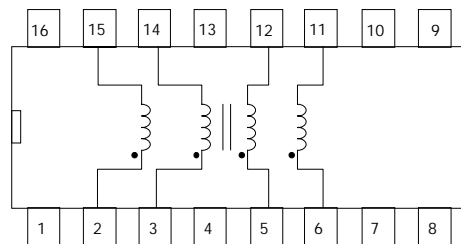



**PACKAGE "7"**

**SCHEMATIC**

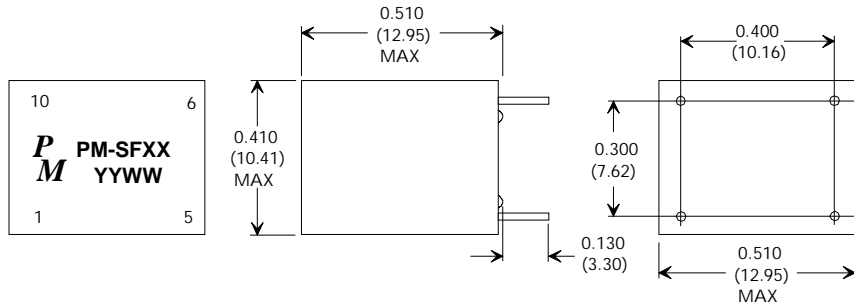

**SCHEMATIC "A"**

