

# SMALL OUTLINE 10/100BASE-T ISOLATION TRANSFORMERS

## FEATURES:

- \* Designed for 10/100BASE-T Applications
- \* Compliant With IEEE 802.3 Standard
- \* 1500 - 3000V IEC950 Isolation Voltages
- \* Versions Available with or without CMC.
- \* Fast Rise Times

## GENERAL SPECIFICATIONS:

- \* Insertion Loss, 1 to 10MHz ..... -0.5 dB Typ.
- \* Return Loss, 1 to 10MHz ..... -20dB Typ.
- \* CMRR, 1 to 10MHz ..... -50dB Typ.
- \* Differential to CMRR, 1 to 10MHz ..... -60dB Typ.
- \* Cross Talk, 1 to 10MHz ..... -45dB Min.

## NORMAL TEMP RANGE

### ELECTRICAL SPECIFICATIONS AT 25°C - OPERATING TEMPERATURE RANGE 0°C TO 70°C

PART NUMBER	TURNS RATIO (PRI:SEC ± 5%)		PRIMARY OCL (μH Min.)	PRI / SEC L <sub>L</sub> (μH Max.)	PRI-SEC Cw/w (pf Max.)	PRI DCR (Ω Max.)	Hi-Pot (Vrms)	CMC	Package/ Schematic
	RCV	XMIT							
PM-1001	1ct:1ct	1ct:1ct	150	0.17	20	0.30	2000	NO	G1/C
PM-1002	1:1	1:1.41	150	0.30	20	0.40	2000	NO	G1/B
PM-1003	1ct:1ct	1ct:1ct	200	0.40	20	0.40	2000	NO	G1/C
PM-1004	1ct:1ct	1ct:1.41ct	150	0.40	20	0.40	2000	YES	G1/D
PM-1005	1ct:1ct	1ct:1.41ct	150	0.30	20	0.40	2000	NO	G1/C
PM-1006	1ct:1ct	1ct:1ct	150	0.40	20	0.80	2000	YES	G1/D
PM-1006H	1ct:1ct	1ct:1ct	150	0.40	20	0.80	2200	YES	G1/D
PM-1007	1ct:2ct	1ct:1ct	150	0.40	20	0.80	2000	YES	G1/D
PM-1008	1ct:1ct	1ct:2ct	112	0.30	8/12	0.80	1500	YES	G1/E
PM-1011	1ct:1ct	1ct:2.50ct	150	0.30	20	0.40	2000	YES	G1/D
PM-1013	1ct:1ct	1ct:1.ct	150	0.30	20	0.40	1500	YES	G1/H
PM-1015	1ct:1ct	1ct:2ct	140	0.40	15	0.30	2000	YES	G1/D

## EXTENDED TEMP RANGE

### ELECTRICAL SPECIFICATIONS AT 25°C - OPERATING TEMPERATURE RANGE -40°C TO +85°C

PART NUMBER	TURNS RATIO (PRI:SEC ± 5%)		PRIMARY OCL (μH Min.)	PRI / SEC L <sub>L</sub> (μH Max.)	PRI-SEC Cw/w (pf Max.)	PRI DCR (Ω Max.)	Hi-Pot (Vrms)	CMC	Package/ Schematic
	RCV	XMIT							
PM-1009	1ct:1ct	1ct:2.50ct	180	0.40	20	0.40	2000	NO	G1/C
PM-1010	1ct:1ct	1ct:1.41ct	180	0.40	15	0.40	2000	YES	G1/D
PM-1012	1ct:2ct	1ct:1ct	note 3	0.30	20	1.0	1500	YES	G1/E
PM-1014	1ct:1ct	1ct:1.41ct	150	0.40	30	0.50	2000	NO	G1/C
PM-1016	1ct:1ct	1ct:1ct	180	0.40	20	0.40	2000	YES	G1/D
PM-1020 <sup>2</sup>	1:1	1:1	200	0.30	25	.030	2000	YES	A8/G
PM-3008 <sup>1</sup>	1ct:1ct	1ct:2ct	150	0.60	18	0.40/0.90	3KV IEC	YES	H1/E
PM-3009 <sup>1</sup>	1ct:1ct	1ct:1ct	150	0.50	20	0.90	3KV IEC	YES	H1/D

## NOTES:

- 1) 3KV ISOLATION VERSIONS ARE BUILT TO UL1950, CSA950 & IEC950 REINFORCED INSULATION REQUIREMENTS
- 2) PM-1020 IS AQUAD DESIGN WITH COMMON MODE CHOKES.
- 3) OCL 1-3 = 50 mH Min., 9-11 = 200 mH Min.

# SMALL OUTLINE 10/100BASE-T ISOLATION TRANSFORMERS

## SCHEMATICS

## G1 PACKAGE

### SCHEMATIC DIAGRAM "B"

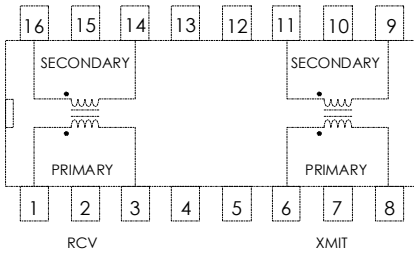

### SCHEMATIC DIAGRAM "C"

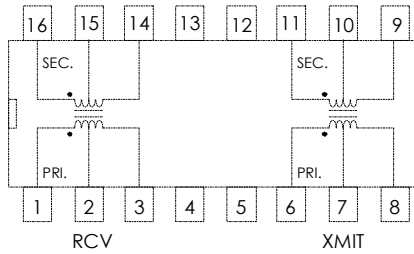

### SCHEMATIC DIAGRAM "D"

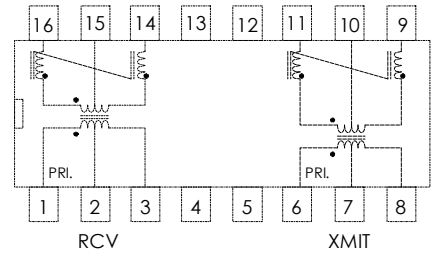

### SCHEMATIC DIAGRAM "E"

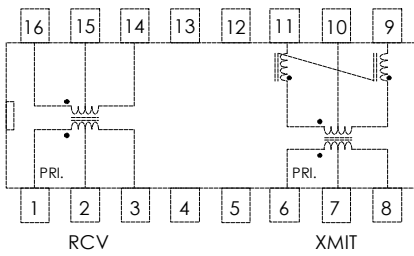

### SCHEMATIC DIAGRAM "F"

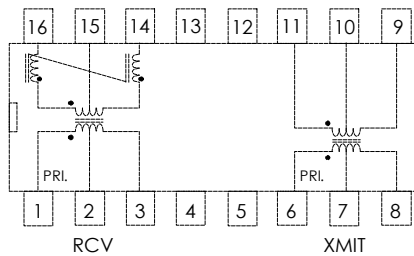

### SCHEMATIC DIAGRAM "H"

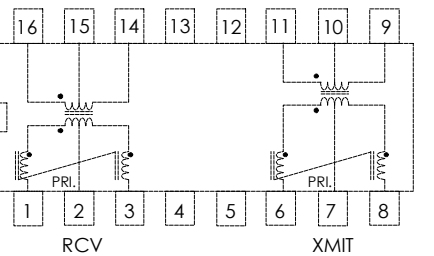

## DIMENSIONS & PCB LAYOUT

## G1 PACKAGE

### PHYSICAL DIMENSIONS .... DIMENSIONS IN INCHES (mm)

### SUGGESTED PCB LAYOUT

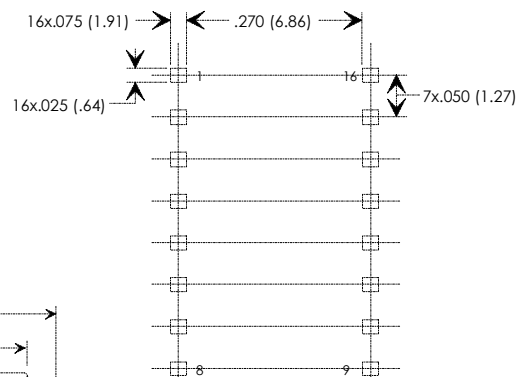
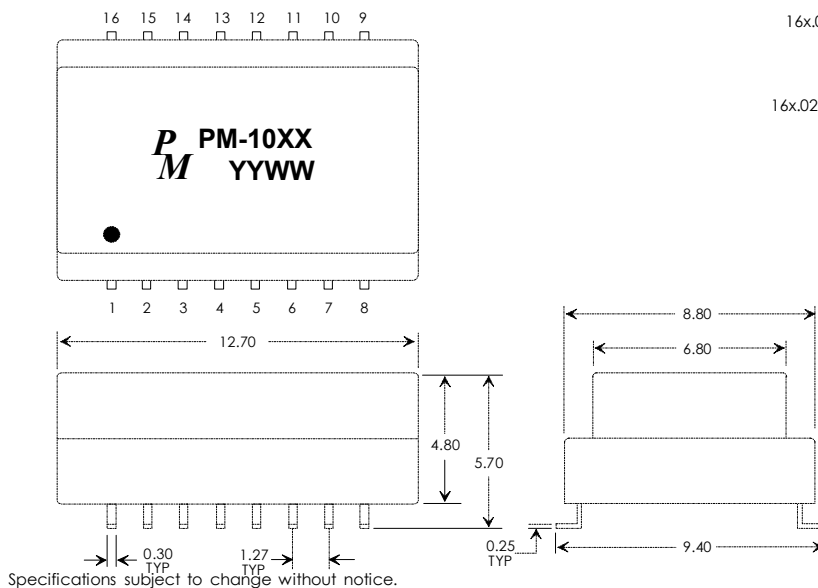

pm-10\_30 09/01

# SMALL OUTLINE 10/100BASE-T ISOLATION TRANSFORMERS

## SCHEMATICS

**SCHEMATIC DIAGRAM "B"**

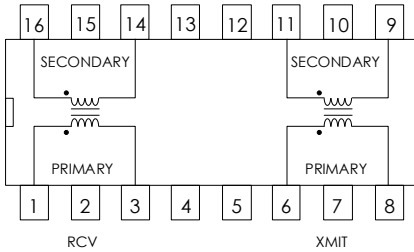

**SCHEMATIC DIAGRAM "C"**

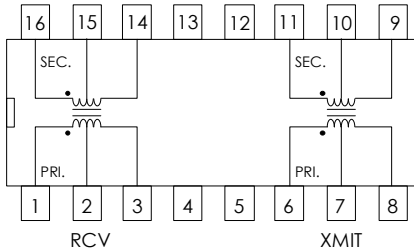

**SCHEMATIC DIAGRAM "D"**

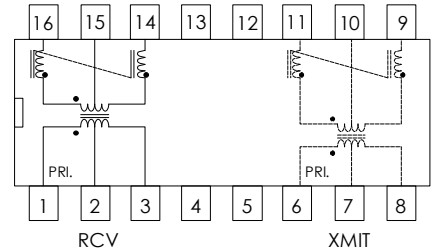

**SCHEMATIC DIAGRAM "E"**

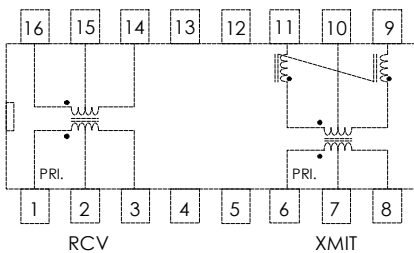

**SCHEMATIC DIAGRAM "F"**

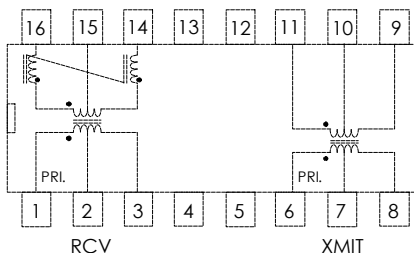

**SCHEMATIC DIAGRAM "H"**

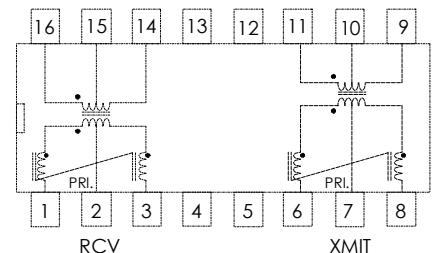

## H1 PACKAGE

## DIMENSIONS & PCB LAYOUT

## H1 PACKAGE

### PHYSICAL DIMENSIONS .... DIMENSIONS IN INCHES (mm)

### SUGGESTED PCB LAYOUT

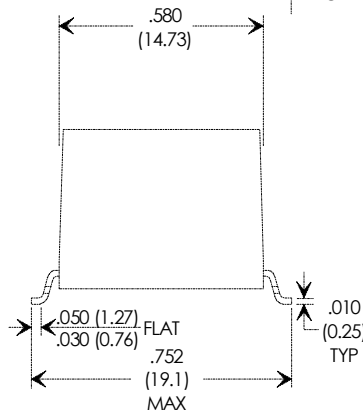
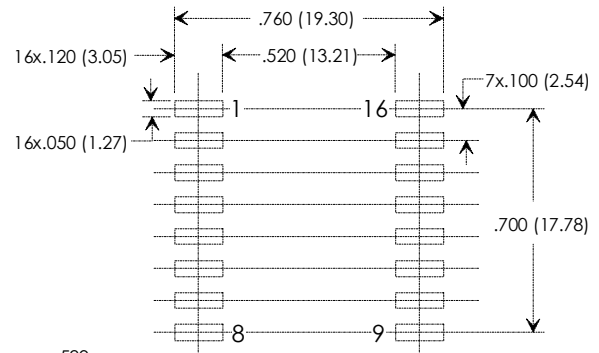
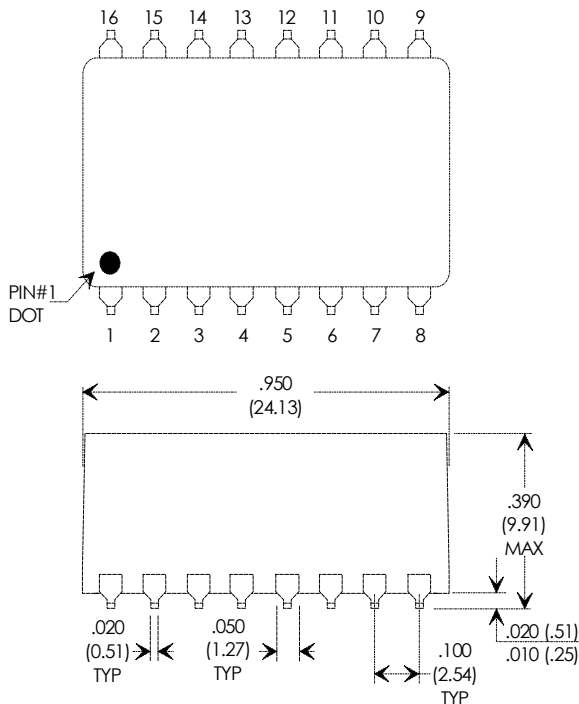

Specifications subject to change without notice.

pm-10\_30 09/01

# SMALL OUTLINE 10/100BASE-T ISOLATION TRANSFORMERS

**SCHEMATIC**

**A8 PACKAGE**

**SCHEMATIC DIAGRAM "G"**

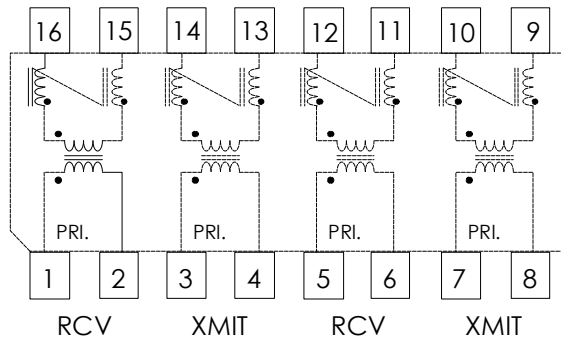

**DIMENSIONS & PCB LAYOUT**

**A8 PACKAGE**

**PHYSICAL DIMENSIONS .... DIMENSIONS IN INCHES (mm)**

